

PXFE211507FC

Thermally-Enhanced High Power RF LDMOS FET 170 W, 28 V, 2110 – 2170 MHz

Description

The PXFE211507FC is a 170-watt LDMOS FET intended for use in multi-standard cellular power amplifier applications in the 2110 to 2170 MHz frequency band. Features include input and output matching, high gain and thermally-enhanced package with earless flange. Manufactured with Wolfspeed's advanced LDMOS process, this device provides excellent thermal performance and superior reliability



PXFE211507FC
Package H-37248G-4/2

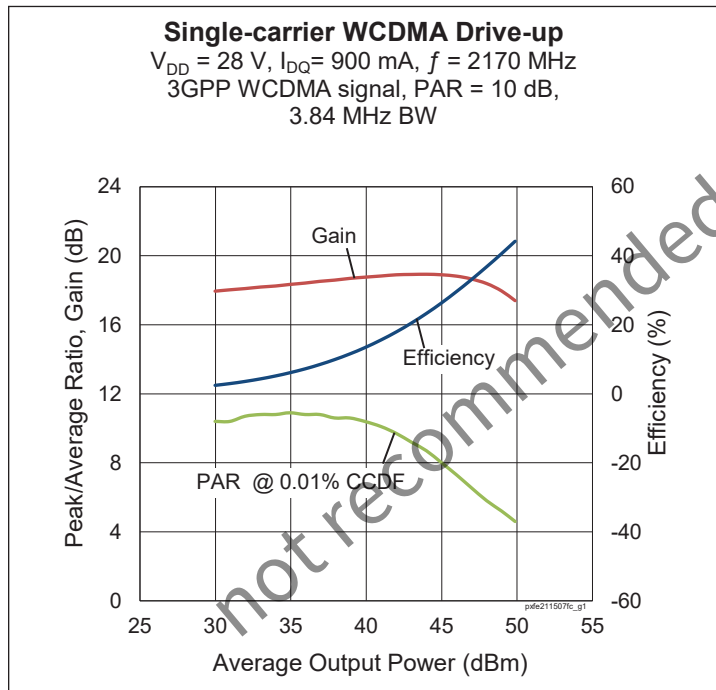

Features

- Broadband internal input and output matching
- Typical Pulsed CW performance, 2140 MHz, 28 V, single side, 16 μs , 10% duty cycle, class AB test
 - Output power at $P_{1dB} = 172\text{ W}$
 - Output power at $P_{3dB} = 208\text{ W}$
 - Efficiency at $P_{3dB} = 64.4\%$
 - Gain = 20.3 dB
- Capable of handling 10:1 VSWR @ 28 V, 120 W (CW) output power
- Human Body Model Class 2 (per ANSI/ESDA/JEDEC JS-001)
- Integrated ESD protection
- Low thermal resistance
- Pb-free and RoHS compliant

Single-carrier WCDMA Specifications (tested in Wolfspeed test fixture)

$V_{DD} = 28\text{ V}$, $I_{DQ} = 900\text{ mA}$, $P_{OUT} = 50\text{ W}$ avg, $f = 2170\text{ MHz}$, 3GPP signal, channel bandwidth = 3.84 MHz, peak/average = 10 dB @ 0.01% CCDF

Characteristic	Symbol	Min	Typ	Max	Unit
Gain	G_{ps}	17	18	—	dB
Drain Efficiency	η_D	33	35	—	%
Adjacent Channel Power Ratio	ACPR	—	-29	-27.5	dBc
Output PAR at 0.01% probability on CCDF	OPAR	5.5	6	—	dB

All published data at $T_{CASE} = 25^\circ\text{C}$ unless otherwise indicated

ESD: Electrostatic discharge sensitive device—observe handling precautions!

DC Characteristics

Characteristic	Conditions	Symbol	Min	Typ	Max	Unit
Drain-Source Breakdown Voltage	$V_{GS} = 0\text{ V}, I_{DS} = 10\text{ mA}$	$V_{(BR)DSS}$	65	—	—	V
Drain Leakage Current	$V_{DS} = 28\text{ V}, V_{GS} = 0\text{ V}$	I_{DSS}	—	—	1	μA
	$V_{DS} = 60\text{ V}, V_{GS} = 0\text{ V}$	I_{DSS}	—	—	10	μA
Gate Leakage Current	$V_{GS} = 10\text{ V}, V_{DS} = 0\text{ V}$	I_{GSS}	—	—	1	μA
On-State Resistance	$V_{GS} = 10\text{ V}, V_{DS} = 0.1\text{ V}$	$R_{DS(on)}$	—	0.03	—	Ω
Operating Gate Voltage	$V_{DS} = 28\text{ V}, I_{DQ} = 900\text{ mA}$	V_{GS}	2.7	3.0	3.3	V

Maximum Ratings

Parameter	Symbol	Value	Unit
Drain-Source Voltage	V_{DSS}	65	V
Gate-Source Voltage	V_{GS}	-6 to +10	V
Operating Voltage	V_{DD}	0 to +32	V
Junction Temperature	T_J	225	$^{\circ}\text{C}$
Storage Temperature Range	T_{STG}	-65 to +150	$^{\circ}\text{C}$

Thermal Characteristics

Characteristic	Symbol	Value	Unit
Thermal Resistance ($T_{CASE} = 70^{\circ}\text{C}, 50\text{ W CW}$)	$R_{\theta JC}$	0.58	$^{\circ}\text{C/W}$

Ordering Information

Type and Version	Order Code	Package	Shipping
PXFE211507FC V1 R0	PXFE211507FC-V1-R0	H-37248G-4/2	Tape & Reel, 50 pcs
PXFE211507FC V1 R2	PXFE211507FC-V1-R2	H-37248G-4/2	Tape & Reel, 250 pcs

Typical Performance (data taken in test fixture)

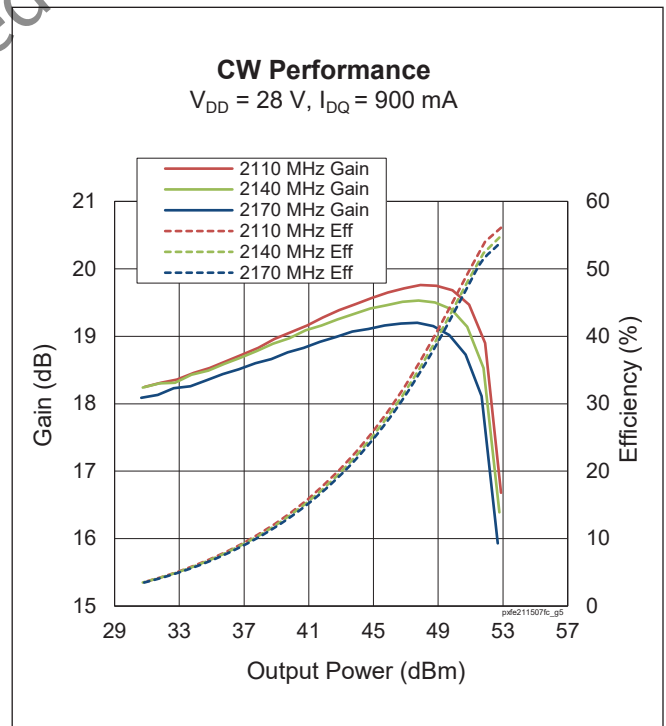
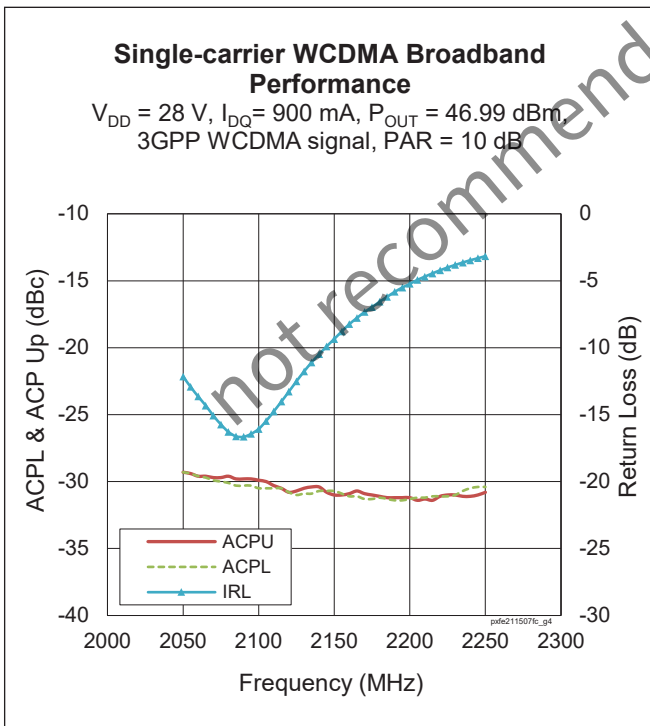
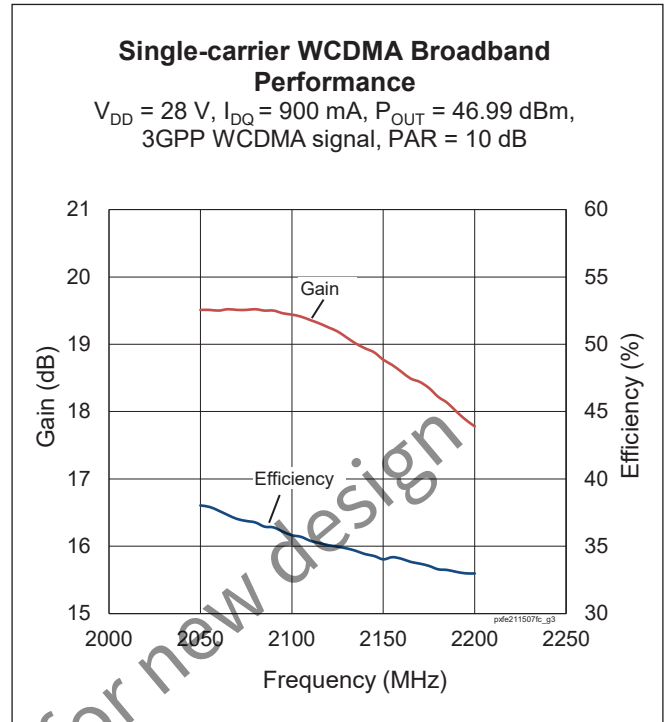
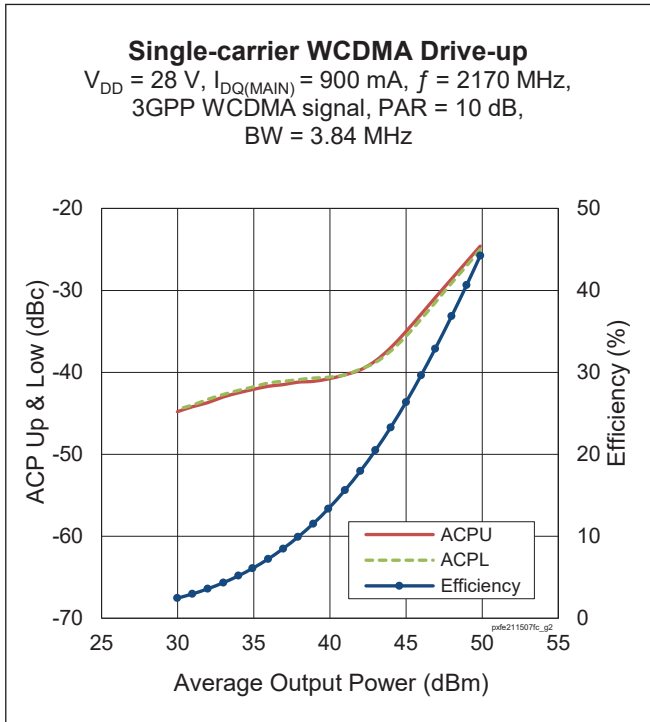

Typical Performance (data taken in test fixture)

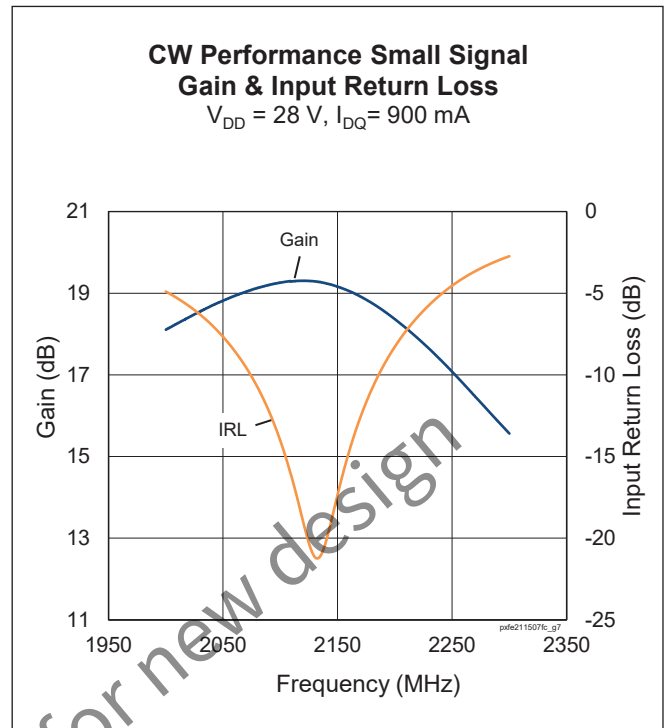
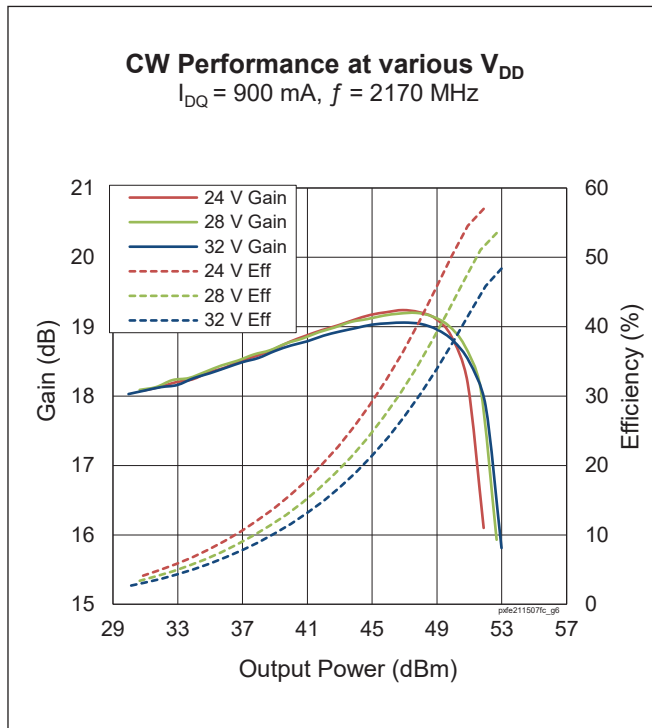

Load Pull Performance

Load Pull Performance – Pulsed CW signal: 16 μs , 10% duty cycle, 28 V, $I_{DQ} = 900 \text{ mA}$

		P_{1dB}									
		Max Output Power					Max Drain Efficiency				
Freq [MHz]	Zs [W]	ZL [W]	Gain [dB]	P_{1dB} [dBm]	P_{1dB} [W]	ηD [%]	ZL [W]	Gain [dB]	P_{1dB} [dBm]	P_{1dB} [W]	ηD [%]
2110	3.3-j5.6	1.6-j3.6	18.6	52.75	188.4	52.7	3-j2	21.2	51.46	140	66.2
2170	5.1-j5	1.6-j3.9	18.3	52.80	190.6	51.4	3.7-j2.3	21.2	50.78	119.7	66.8

		P_{3dB}									
		Max Output Power					Max Drain Efficiency				
Freq [MHz]	Zs [W]	ZL [W]	Gain [dB]	P_{3dB} [dBm]	P_{3dB} [W]	ηD [%]	ZL [W]	Gain [dB]	P_{3dB} [dBm]	P_{3dB} [W]	ηD [%]
2110	3.3-j5.6	1.8-j3.9	16.7	53.56	227	56.8	4.3-j1.33	19.9	50.76	119.1	68.0
2170	5.1-j5	1.65-j3.9	16.5	53.64	231.2	55.8	3.7-j2.3	19.2	51.56	143.2	68.2

Reference Circuit, 2110 – 2170 MHz

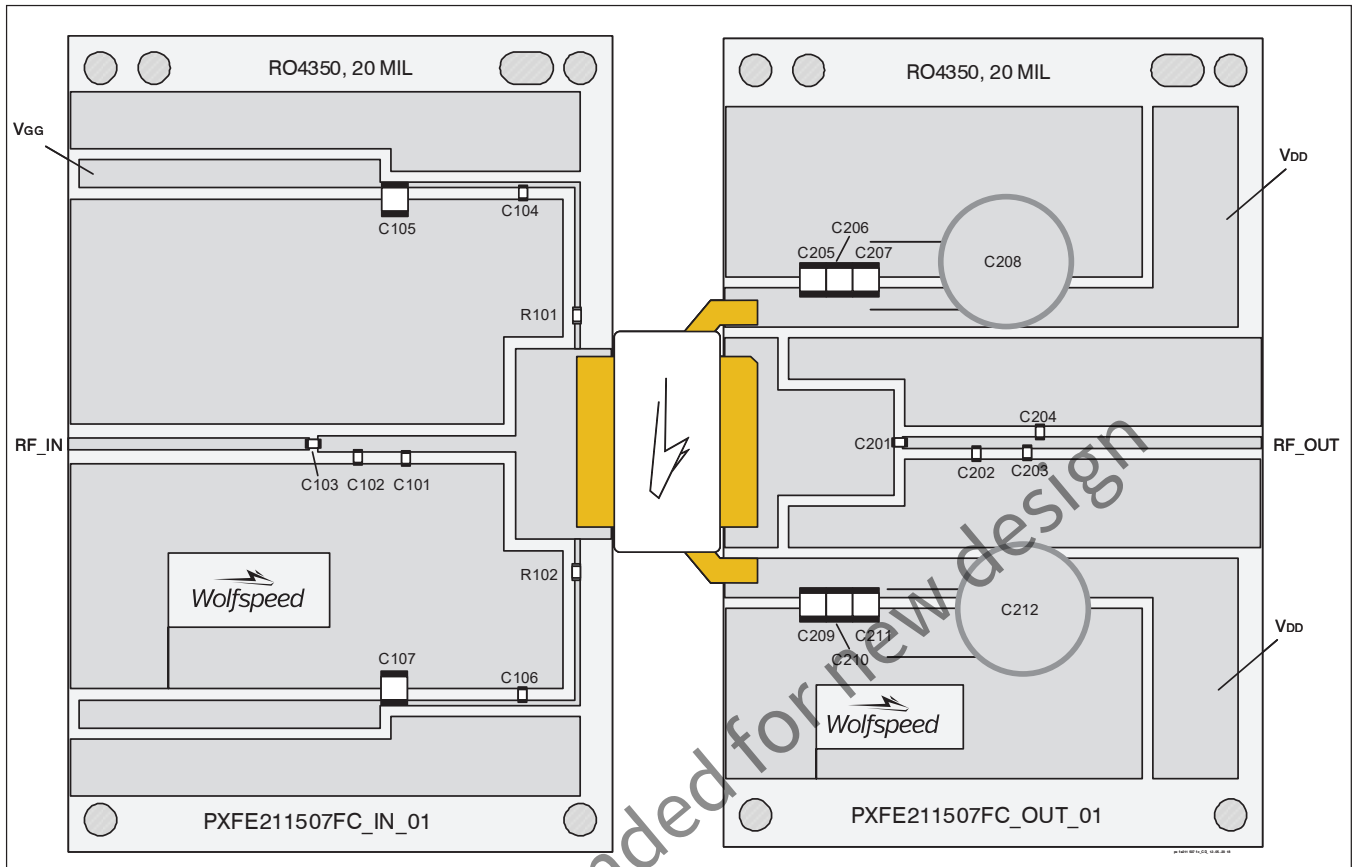

Reference circuit assembly diagram (not to scale)

Reference Circuit Assembly

DUT	PXFE211507FC V1
Test Fixture Part No.	LTN/PXFE211507FC-V1
PCB	Rogers 4350, 0.508 mm [0.020"] thick, 2 oz. copper, $\epsilon_r = 3.66$, $f = 2110 - 2170$ MHz
Find Gerber files for this test fixture on the Wolfspeed Web site at www.wolfspeed.com/RF	

Components Information

Component	Description	Manufacturer	P/N
Input			
C101, C102	Capacitor, 0.4 pF	ATC	ATC600F0R4AT250BT
C103, C104, C106	Capacitor, 10 pF	ATC	ATC600F100JT250XT
C105, C107	Capacitor, 50 V, 10 μ F	Taiyo Yuden	UMK325C7106MM-T
R101, R102	Resistor, 10 ohms	Panasonic Electronic Components	ERJ-3GEYJ100V
Output			
C201	Capacitor, 18 pF	ATC	ATC600F180JT250XT
C202	Capacitor, 0.4 pF	ATC	ATC600F0R4BT250XT
C203, C204	Capacitor, 0.6 pF	ATC	ATC600F0R6BT250XT
C205, C206, C207, C209, C210, C211	Capacitor, 50 V, 10 μ F	Taiyo Yuden	UMK325C7106MM-T
C208, C212	Capacitor, 100 V, 220 μ F	Panasonic Electronic Components	ECA-2AHG221



Pinout Diagram (top view)

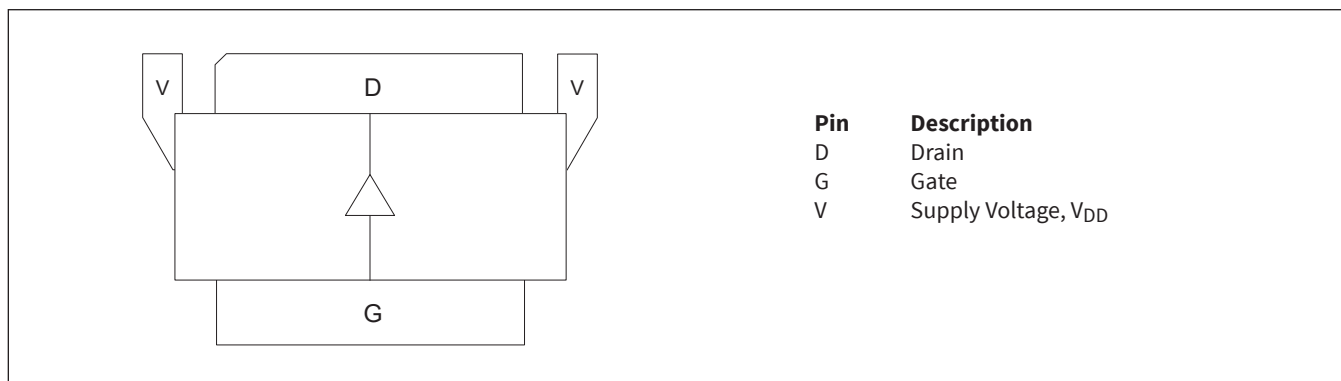

Lead connections for PXFE211507FC

not recommended for new design

Package Outline Specifications

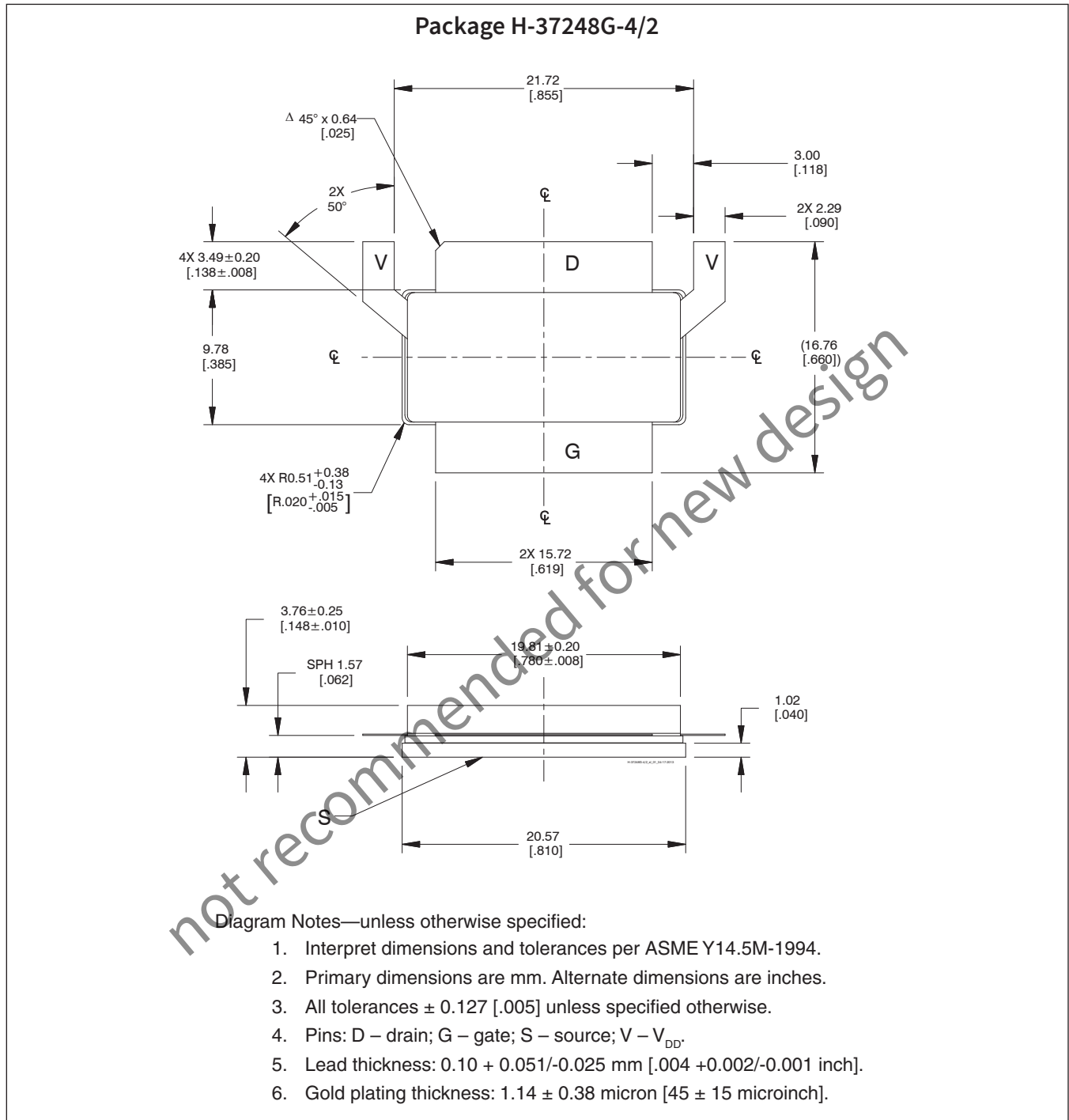



Revision History

Revision	Date	Data Sheet Type	Page	Subjects (major changes since last revision)
01	2018-09-12	Advance	All	Data Sheet reflects advance specification for product development
02	2019-01-15	Production	All	Data Sheet reflects released product specification

For more information, please contact:

4600 Silicon Drive
 Durham, North Carolina, USA 27703
www.wolfspeed.com/RF

Sales Contact
RFSales@wolfspeed.com

RF Product Marketing Contact
RFMarketing@wolfspeed.com
 919.407.7816

not recommended for new design

Notes

Disclaimer

Specifications are subject to change without notice. Cree, Inc. believes the information contained within this data sheet to be accurate and reliable. However, no responsibility is assumed by Cree for any infringement of patents or other rights of third parties which may result from its use. No license is granted by implication or otherwise under any patent or patent rights of Cree. Cree makes no warranty, representation or guarantee regarding the suitability of its products for any particular purpose. “Typical” parameters are the average values expected by Cree in large quantities and are provided for information purposes only. These values can and do vary in different applications and actual performance can vary over time. All operating parameters should be validated by customer’s technical experts for each application. Cree products are not designed, intended or authorized for use as components in applications intended for surgical implant into the body or to support or sustain life, in applications in which the failure of the Cree product could result in personal injury or death or in applications for planning, construction, maintenance or direct operation of a nuclear facility.

Copyright © 2018 Cree, Inc. All rights reserved. The information in this document is subject to change without notice. Wolfspeed™ and the Wolfspeed logo are trademarks of Cree, Inc.